

MODEL OT 120
FRONT VIEW

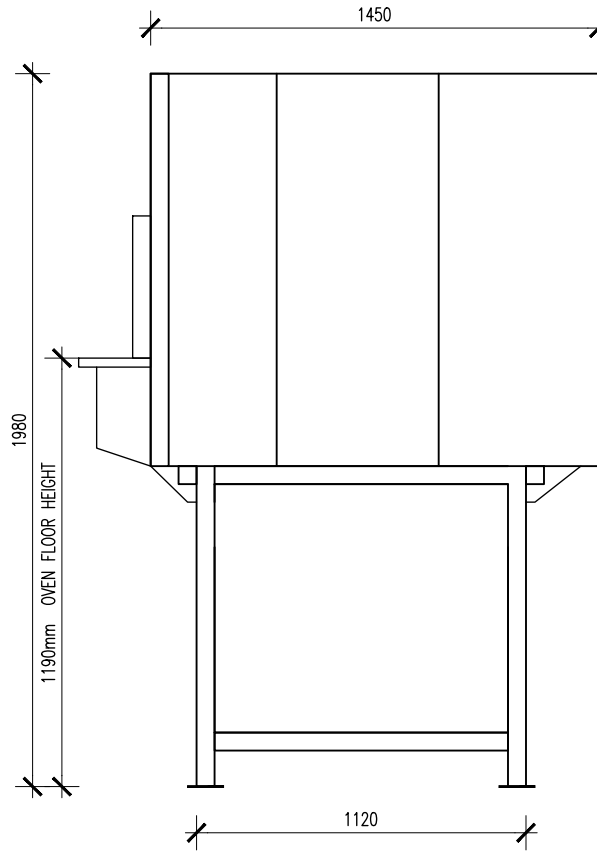

MODEL OT 120
SIDE VIEW

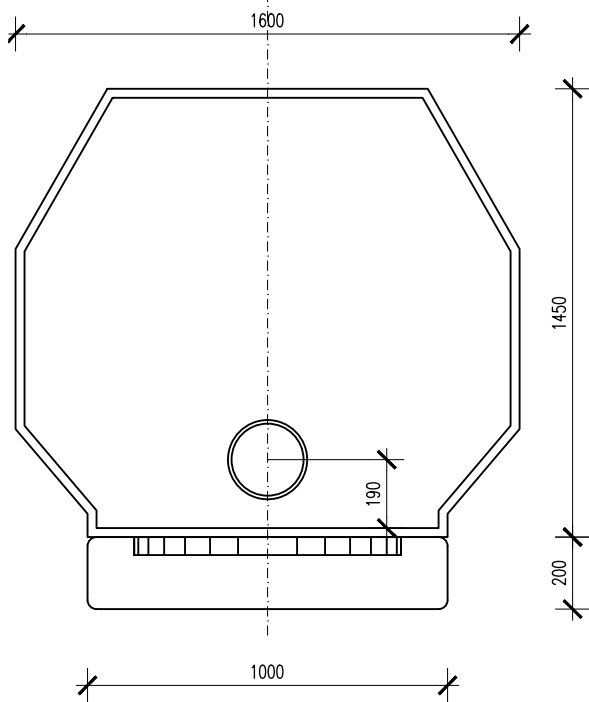

MODEL OT 120
PLAN VIEW

NOTES:

CLEARANCES:

Install the oven with a minimum 25mm clearance on sides and back to combustible construction.

VENTING:

By Approved Ventilation Specialist.

This drawing is copyright and the confidential information of Cassisi Corp Pty Ltd, trading as Euroquip, trading as Vesuvio Wood Fired Ovens.

Unauthorised use, copying and disclosure is prohibited.

Do not scale this drawing. Use figured dimensions only. Dimensions are to be checked and verified before commencing work.

© copyright